



Durable Products for Hazardous Environments

Perfect bundling, fixing, protection and identification

HellermannTyton

HellermannTyton Metal Systems

Durable products for harsh environments

HellermannTyton – Ready for extreme conditions

Whenever the environment is harsh, the demand is for complete reliability. That's why HellermannTyton is the right partner by your side to meet the challenges of modern cable management. For over 75 years we've been using our experience and innovative drive for the benefit of our customers in markets throughout the world. And when it comes to producing specialised solutions, our customers know we're the best. It's because our metal systems offer the advantages our customers need to meet the daily business challenges. **Under extreme conditions, such as high temperature fluctuation, wet environments or whenever chemicals are a factor, your highest priority will be to protect your applications.** Our metal systems are based on the highest product quality and are manufactured to assure the utmost level of safety – even when the going gets tough!

Once you get to know the advantages of our metal products, you won't want to look further than HellermannTyton – because trust is built on quality.

Discover the power of our cable management solutions

Our specialised full-metal products and tools offer easier, faster and longer lasting solutions. These allow you to meet any challenge, even under the most extreme conditions. Discover the sustained performance of:

- Stainless Steel Identification Products
- Bundling & Fixing Cable Tie Systems
- HelaGuard Cable Protection Systems
- Manual & Pneumatic Processing Tools



Advanced Materials and Testing Series

Highest quality for achieving maximum reliability

The durability of our products starts with first-class materials

Our products are made using the highest quality stainless steel. They are engineered with smooth surfaces, rounded edges and the correct hardness for safe, quick and easy-to-use cables. By using coated stainless steel cable ties we are able to prevent corrosion of any type between dissimilar materials. Our products are sustainable, regardless of whether cable ties are exposed to extreme temperatures, harsh climates and forces of weathering, or salt. Reliability has been verified by international partners and institutes that, throughout the complete product life cycle, test and certify our products and the materials used to manufacture them.

Our products are tested according to the IEC 62275 specification, with certifications and approvals ranging from DNV and ABS to Bureau Veritas.



Material overview stainless steel

Properties of 304/316 steel (similar to V2A/V4A steel)

MATERIAL	Material Shortcut	Operating Temperature	Flammability	Material Properties*	Material Specifications
Stainless Steel, Stainless Steel	SS304, SS316	-80 °C to +538 °C	non-burning	<ul style="list-style-type: none"> Corrosion resistant Antimagnetic Weather resistant Outstanding chemical resistance 	HF LFH RoHS
Polyester	SP	-50 °C to +150 °C	halogen free	<ul style="list-style-type: none"> UV-resistant Good chemical resistance to: most acids, alkalis and oils 	HF LFH RoHS

* These details are only rough guide values. They should be regarded as a material specification and are no substitute for a suitability test. Please see our datasheets for further details.

Our Test Lab – Six ways we prove quality

We leave nothing to chance. To ensure the highest quality, our products and the materials used to manufacture them are subjected to continuous testing.



Loop Tensile Strength Test

The test is carried out on a calibrated tensometer, whereby the cable tie is assembled around a mandrel with a specific diameter. This method measures the strength of an installed cable tie. HellermannTyton ties are among the strongest anywhere in the world.

Heat-Aging Test

In a controlled Heat-Aging Test we simulate extreme conditions over a specified period of time. Our cable ties are made of the highest quality stainless steel (even the ball in the MBT-Series is made using stainless steel). Our products are designed to withstand the Heat-Aging Test, ensuring they are suitable for use in harsh environments.

Vibration & Shock Test

During this test, the cable ties are fixed as they would be in a practical situation (i.e. to a cable tray) and are subjected to various levels of vibration and shock loading. To pass this test, cables must remain fastened to the cable tray and show no signs of damage.

Weathering Test

In a controlled Weathering Test we simulate extreme conditions, such as the influence of strong ultraviolet light. Our cable ties are made of the highest quality stainless steel and are designed to withstand weathering, ensuring their suitability for use in harsh environments.

Salt Spray Test

Our highest quality SS316 is subjected to a Salt Spray Test in a controlled test room. Ties of this type must complete the test without showing any sign of corrosion or stain. SS316 cable ties are therefore ideal for use in shipbuilding and offshore applications.

Insertion Force Test

This test is carried out on a calibrated tensometer. The cable tie is assembled to pull the strap through the head of the tie. HellermannTyton cable ties have a very low insertion force, which means they are extremely easy to use in applications.

Metal Products of Choice

Meeting your requirements wherever you work

Stainless Steel Identification Products



Flexibility and mobility
with powerful performance

Discover M-BOSS Compact, a user friendly on-site printer that runs on a standard electrical supply. The stainless steel plates are embossed and can survive in the toughest environments.

→ Page 10

Bundling & Fixing Cable Tie Systems



The ultimate solution
for harsh environments

Whether used indoors or outdoors, our stainless steel cable ties are reliable and offer a perfect solution. HellermannTyton bundling and fixing cable tie systems are manufactured from the finest materials, and design quality ensures sustainability and the long-term performance of your installation. Available in a wide range of widths and lengths, our systems offer a complete solution.

→ Page 16

Manual & Pneumatic Processing Tools



Quick and easy installation
in heavy industries

HellermannTyton offers a range of tools for light, medium and heavy applications. Fitted with comfortable grips, these tools provide continuous high performance for fastening cable ties and ensure a flush cut-off to protect both the cable bundle and the safety of the user. These application tools provide a cost-effective way to install cable ties.

→ Page 38

HelaGuard Cable Protection Systems



Reliable mechanical protection
for the toughest applications

HelaGuard flexible metallic conduits and fittings provide secure protection for cables under the toughest conditions. Whether in stainless steel or galvanised steel, HelaGuard metallic conduits can be combined with a wide variety of robust stainless steel or brass fittings to provide the optimal system solution.

→ Page 32

Stainless Steel Identification Products

Tough products for your harsh identification needs

Metal Plate Embossing Printer



- Simple to set up, easy to operate
- Fast print speeds
- Standard electrical supply
- Desktop size

Identification **M-BOSS Compact Printer**
Your ideal on-site metal plate embossing printer



A quiet, durable, and easy to use metal plate embossing printer.

Stainless Steel Printing System

• **M-BOSS Compact**

M-BOSS Compact is a quiet easy-to-use metal plate embossing printer with a small production footprint. It is simple to install and operate and only needs a standard electrical supply and a PC. Texts are created with Tagprint Pro 3.0. Simply open the easy to use program to create print lists.

Improved cooling system now ensures a continuous operation between 8-10 hours.

Marker plates are attached to pipes and cables using 4.6 mm width MBT cable ties and a MK9SST hand tool.

• **M-BOSS Compact and Organiser**

M-BOSS Compact and Organiser system gives the added advantage of a self-contained storage system within the print unit. The organiser is a 10 container carousel storage system that can be programmed to hold either an individual or a pre-defined set of marker plates. This means that users have the flexibility to manage how they work with the printed output. A simple input screen on the top of the machine is used to specify the quantity per container within the carousel. The carousel drawer when opened extends 430 mm from the front of the printer.

TYPE	Pack Cont.	Article-No.
M-BOSS Compact and Organiser	1	544-21000

All dimensions in mm. Subject to technical changes.
Minimum Order Quantity (MOQ) may differ from package content.

Power Supply	110 Volt AC- 240 Volt AC 50/60 Hz
Cycle Time	1 second per character
Dimensions W x H x D	480 mm x 360 mm x 570 mm
Weight	41 kg

Patent Pending

RoHS

TYPE	Pack Cont.	Article-No.
M-BOSS Compact	1	544-20000

All dimensions in mm. Subject to technical changes.
Minimum Order Quantity (MOQ) may differ from package content.



A simple solution to managing your printer output.

Identification **M-BOSS Compact Marker Plates**
Embossed markers for the harshest conditions



Identification for hazardous environments: M-BOSS Compact stainless steel markers.

Stainless Steel Printing System

• **M-BOSS Compact Markers**

M-BOSS Markers are used in all areas where severe mechanical or chemical conditions occur e.g. offshore industry, marine engineering, petrochemical industry, mining, underground or on radio and cellular masts where mark permanence is critical.

The raised surface of the embossed print ensures that the text remains visible even with dirt, grease, and paint cover the marker. The physical characteristics of the metal and the height of the embossed mark allows users to apply a stiff or metallic brush to the surface and remove excess layers of paint or grease without damaging the integrity of the text.

MATERIAL	Stainless Steel (SS316)
Operating Temperature	-80 °C to +538 °C

HF ✓ LFH ✓ RoHS ✓

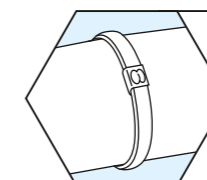

Easily fix your markers with **MBT Cable Ties** and our **MK9SST Hand Tool**.

Features and Benefits

- Raised marking ensure text visibility even when covered in dust, debris, grease and oil
- Stainless steel grade SS316 is suited for use in harsh environments
- Marker plates are designed for use with stainless steel cable ties with a 4.6 mm strap width
- Apply ties with a MK9SST

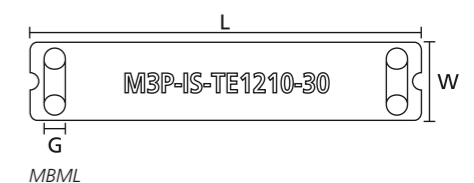

TYPE	Strap Width max. (G)	Number of lines	Characters per line	Number of characters	Width (W)	Length (L)	Pack Cont.	E-number	Article-No.
MBML10X45	4.6	1	8	8	10.0	45.0	1,000	00 000 00	544-80101
MBML10X90	4.6	1	23	23	10.0	90.0	500	00 000 00	544-80102
MBML20X45	4.6	3	8	24	20.0	45.0	1,000	00 000 00	544-80201
MBML20X90	4.6	3	23	69	20.0	90.0	500	00 000 00	544-80202

All dimensions in mm. Subject to technical changes.
Minimum Order Quantity (MOQ) may differ from package content.

Identification **Metal Plate Print Service** Customised metal plates – embossed or laser marked

Identification **Hellermark SSM** Identification to go with pre-embossed marker tiles



Customised printing to suit your needs.

Hellermark SSC and SSM.

Stainless Steel Printing System

• **M-BOSS Print Service**

Customised embossed stainless steel SS316 markers are now available. Simply send required texts electronically for perfect embossed markers. Characters are embossed so that dirt, dust, paint and debris can be removed leaving a clear visible mark.

MBC marker plates are designed with a high bridge that allows both plastic and metal cable ties up to 7.9 mm wide and 0.27 mm thick, and plastic ties up to 4.6 mm wide and 1.5 mm thick. The MBML range of marker plates can only be used with metal ties up to 4.6 mm wide.

• **Laser Beam Marked Metal Plates and Ties**

Customised stainless steel SS316 markers are now available. Simply send required texts, barcodes, and logos electronically for perfect laser etched marker plates.

- Excellent character legibility
- Resistant to weathering and extreme levels of UV light
- Printed mark will last the lifetime of the metal plate and cable tie
- MBC or MBML marker plates are possible

Stainless Steel Pre-embossed Marking System, manual

- **Hellermark SSC**
- **Hellermark SSM**

Hellermark is used in the rail, marine, offshore, petrochemical, food and construction industries, for the identification of cables, pipes and other equipment in harsh environments.

Features and Benefits

- Stainless steel pre-embossed marker tiles and carriers
- Made of grade 316 stainless steel for ideal use in aggressive environments
- Insert marker tiles (SSM) into fitting carrier (SSC) and either seal with a plastic cap (SSCPP) or close ends with pliers
- Fasten carriers using stainless steel cable ties with max. strap width of 8 mm
- Carrier can be riveted or screw-fixed using two 3 mm holes at each end

MATERIAL	Stainless Steel (SS316)
Operating Temperature	-80 °C to +538 °C

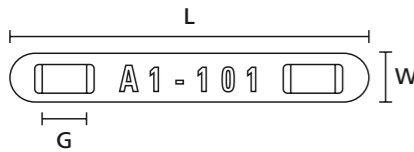

MBC

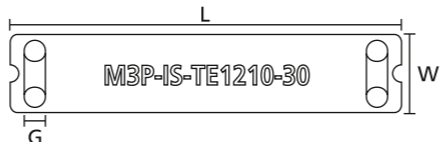

MBML

TYPE	Strap Width max. (G)	Number of lines	Characters per line	Number of characters	Width (W)	Length (L)	Pack Cont.	Article-No.
MBCE-DE10X60	8.0	1	10	10	10.0	60.0	10	540-10048
MBCE-DE10X80	8.0	1	15	15	10.0	80.0	10	540-10049
MBCE-DE10X100	8.0	1	20	20	10.0	100.0	10	540-10003
MBCE-DE14X100	8.0	2	20	40	14.0	100.0	10	540-10050
MBML10X45	4.6	1	8	8	10.0	45.0	1,000	544-80103
MBML10X90	4.6	1	23	23	10.0	90.0	500	544-80104
MBML20X45	4.6	3	8	24	20.0	45.0	1,000	544-80203
MBML20X90	4.6	3	23	69	20.0	90.0	500	544-80204

All dimensions in mm. Subject to technical changes. Minimum Order Quantity (MOQ) may differ from package content.

TYPE	Marking Text	Article-No.
SSM	-	540-01703
	,	540-01702
	/	540-01720
	.	540-01701
	+	540-01700
	±	540-01730
	0	540-01600
	1	540-01610
	2	540-01620
	3	540-01630
	4	540-01640
	5	540-01650
	6	540-01660
	7	540-01670
	8	540-01680
9	540-01690	
A	540-01010	
B	540-01020	
C	540-01030	
D	540-01040	
E	540-01050	

TYPE	Marking Text	Article-No.
SSM	F	540-01060
	G	540-01070
	H	540-01080
	I	540-01090
	J	540-01100
	K	540-01110
	L	540-01120
	M	540-01130
	N	540-01140
	O	540-01150
	P	540-01160
	Q	540-01170
	R	540-01180
	S	540-01190
	T	540-01200
U	540-01210	
V	540-01220	
W	540-01230	
X	540-01240	
Y	540-01250	
Z	540-01260	

All dimensions in mm. Subject to technical changes. Package content of 200 pcs.

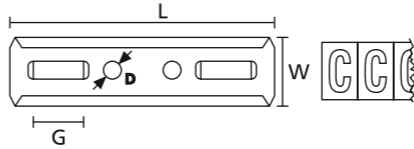

TYPE	Width (W)	Length (L)	Marker tiles per carrier	Pack Cont.	Article-No.
SSCPP (Plastic)	-	7.0	-	100	540-02011
SSC46	11.0	46.0	5	10	540-01046
SSC56	11.0	56.0	7	10	540-01056
SSC82	11.0	82.0	11	10	540-01082
SSC106	11.0	106.0	15	10	540-01106
SSC134	11.0	134.0	20	10	540-01134
SSC286	11.0	286.0	45	10	540-01286

All dimensions in mm. Subject to technical changes. Minimum Order Quantity (MOQ) may differ from package content.

Cable Tie Solutions for Bundling & Fixing

Suitable for demanding and harsh environments



High Performance Metal Cable Ties



- High class materials
- Made of stainless steel
- Longlasting durability
- High tensile strength
- Vibration resistant

Metal Ball Locking Cable Ties (MBT)

A highly innovative solution from HellermannTyton

Introduction to the intelligent Metal Ball Locking Technology used for cable ties

HellermannTyton offers a wide range of cable ties for use in different applications. By constantly refining our products and satisfying the ever-changing demands of the market, various locking technologies have been developed.

Metal Ball Locking Cable Tie MBT-Series

Made of stainless steel grade 304 or 316, the MBT range of cable ties have no serrations on the strap and are threaded parallel through the head, gliding under a metal ball-bearing locking mechanism.

Metal Ball Locking Technology

The strap is locked into the head by means of the small ball-bearing. The ball locks into the small end of the wedged shaped housing, forming a positive locking with the strap. This cable tie is not suitable for rigid objects. Retraction of the ball-bearing (see drawing) is required into the small end of the wedged shaped housing to allow for a positive locking of the strap and also to make a flush cut of the end of the strap.

Retraction, therefore, cannot take place with the bundling of inflexible materials.

To bundle rigid objects LFPC channel should be laid as buffer between strap and bundled

material to compensate for this retraction. This locking technology allows for minimum tensile strengths of up to 7,000 Newton.

The ideal combination

The MBT-Series (up to 7.9 mm) can be used for fixing stainless steel markers like M-BOSS Compact. This ensures a sustainable way of identification.

The MBT-Series (up to 7.9 mm) can also be used in combination with the stainless steel P-Mount. The mount is simple to install with a screw or bolt and ensures a durable fixation solution.

1. Initial position

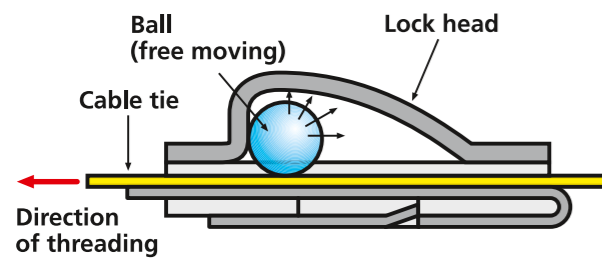

2. Ball locks cable tie by wedging.

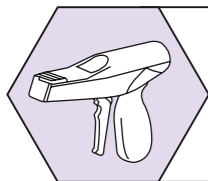
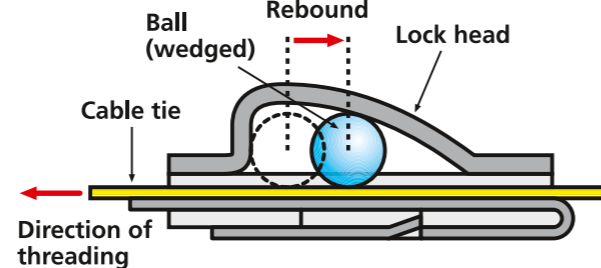

There are various processing tools available for different diameters and purposes to apply the MBT-Series.

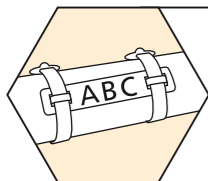

MBT cable ties can also be used in combination with HellermannTyton's identification marker plates – M-BOSS Compact and Hellermark.

= Minimum Tensile Strength

HellermannTyton's Metal Cable Ties

From standard to specialist features

Metal Ball Locking Tie (MBT)

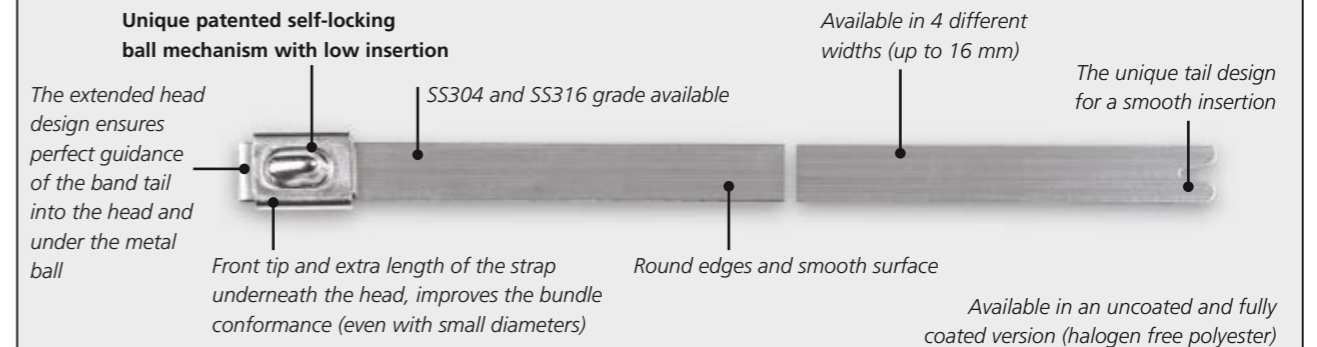

Metal Fold Locking Tie (MLT)

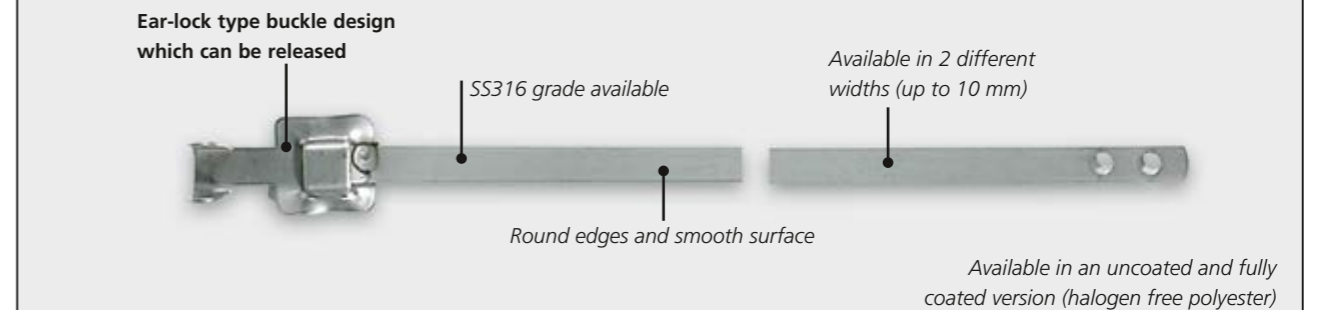

Metal Punch Lock Tie (MST)

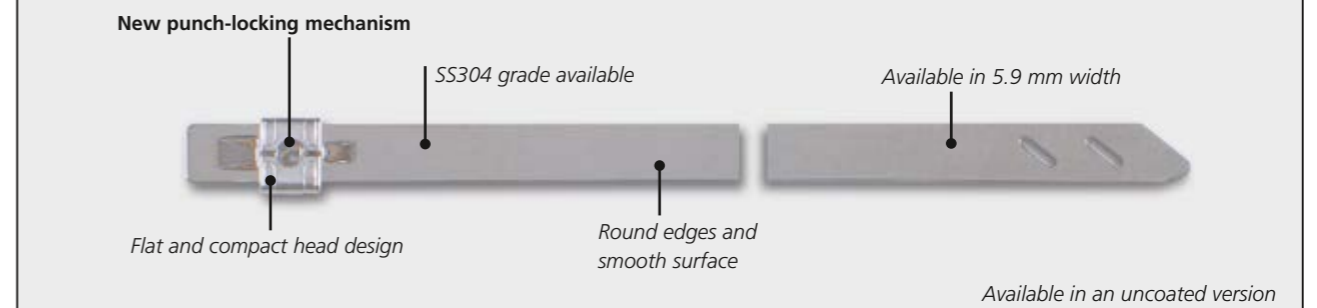

Metal Banding for Heavy Duty Application (AMT)

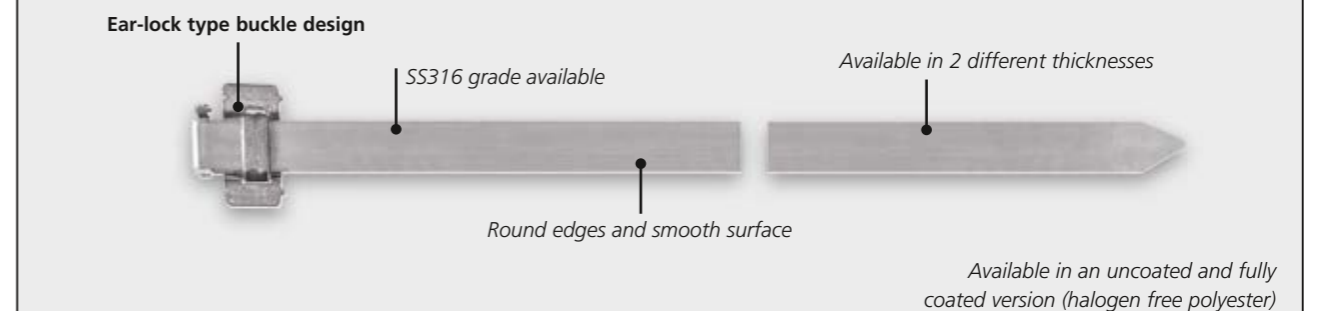

MBT Cable Ties Discover the unique power of the ball locking mechanism



MBT_SS, MBT_HS.

MBT_XHS.

Cable Ties with Ball-Lock

- MBT-Series

Metal ties are ideal for all applications that require high strength, reliability and fire resistance. The MBT range of stainless steel cable ties can be used in chemical industries and on oil platforms as well as in mass transit, shipbuilding and mining industries. MBT ties are also suitable for machine building, apparatus construction and in the outside area of radio technology. Additionally, MBT ties are ideal for securing lighting in theatres and exhibition halls.

MATERIAL	Stainless Steel (SS304)
Operating Temperature	-80 °C to +538 °C
Flammability	non-burning

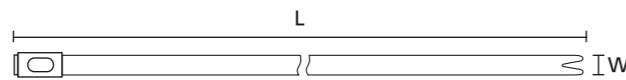

MBT-Series 4.6 mm and 7.9 mm width

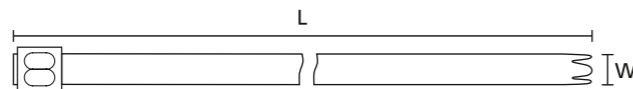

MBT-Series 12.3 mm width

TYPE	Width (W)	Length (L)	Bundle Ø max.	N	Material	Pack Cont.	Article-No.
MBT5SS	4.6	127.0	25.0	900	SS304	100	111-93058
MBT8SS	4.6	201.0	50.0	900	SS304	100	111-93088
MBT14SS	4.6	362.0	102.0	900	SS304	100	111-93148
MBT20SS	4.6	521.0	152.0	900	SS304	100	111-93208
MBT27SS	4.6	685.0	203.0	900	SS304	100	111-93278
MBT33SS	4.6	838.0	254.0	900	SS304	100	111-93338
MBT8HS	7.9	201.0	50.0	2,000	SS304	50	111-94088
MBT14HS	7.9	362.0	102.0	2,000	SS304	50	111-94148
MBT20HS	7.9	521.0	152.0	2,000	SS304	50	111-94208
MBT27HS	7.9	685.0	203.0	2,000	SS304	50	111-94278
MBT33HS	7.9	838.0	254.0	2,000	SS304	50	111-94338
MBT14XHS	12.3	362.0	102.0	2,700	SS304	50	111-95148
MBT20XHS	12.3	521.0	152.0	2,700	SS304	50	111-95208
MBT27XHS	12.3	681.0	203.0	2,700	SS304	50	111-95278
MBT33XHS	12.3	838.0	254.0	2,700	SS304	50	111-95338

All dimensions in mm. Subject to technical changes. The MBT-Series (up to 7.9 mm) can be used in combination with the stainless steel P-Mount. The mount is simple to install with a screw or bolt and ensures a durable fixing solution. Minimum Order Quantity (MOQ) may differ from package content. Other packaging options may also be available.

A highly innovative solution from HellermannTyton



MBT_S, MBT_H.

MBT_XH.

MBT_UH.

Cable Ties with Ball-Lock

- MBT-Series

MATERIAL	Stainless Steel (SS316)
Operating Temperature	-80 °C to +538 °C
Flammability	non-burning



MBT-Series 4.6 mm and 7.9 mm width

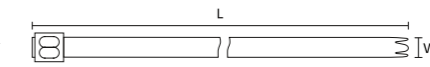

MBT-Series 12.3 mm width

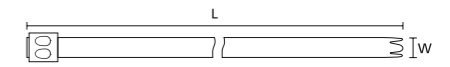

MBT-Series 16 mm width

TYPE	Width (W)	Length (L)	Bundle Ø max.	N	Material	Pack Cont.	Article-No.
MBT5S	4.6	127.0	25.0	900	SS316	100	111-93059
MBT8S	4.6	201.0	50.0	900	SS316	100	111-93089
MBT14S	4.6	362.0	102.0	900	SS316	100	111-93149
MBT20S	4.6	521.0	152.0	900	SS316	100	111-93209
MBT27S	4.6	685.0	203.0	900	SS316	100	111-93279
MBT33S	4.6	838.0	254.0	900	SS316	100	111-93339
MBT8H	7.9	201.0	50.0	2,000	SS316	50	111-94089
MBT14H	7.9	362.0	102.0	2,000	SS316	50	111-94149
MBT20H	7.9	521.0	152.0	2,000	SS316	50	111-94209
MBT27H	7.9	685.0	203.0	2,000	SS316	50	111-94279
MBT33H	7.9	838.0	254.0	2,000	SS316	50	111-94339
MBT14XH	12.3	362.0	102.0	2,700	SS316	50	111-95149
MBT20XH	12.3	521.0	152.0	2,700	SS316	50	111-95209
MBT27XH	12.3	681.0	203.0	2,700	SS316	50	111-95279
MBT33XH	12.3	838.0	254.0	2,700	SS316	50	111-95339
MBT14UH	16.0	362.0	102.0	4,100	SS316	50	111-01301
MBT20UH	16.0	521.0	152.0	4,100	SS316	50	111-01302
MBT27UH	16.0	681.0	203.0	4,100	SS316	50	111-01303
MBT33UH	16.0	838.0	254.0	4,100	SS316	50	111-01304
MBT43UH	16.0	1,092.0	330.0	4,100	SS316	25	111-01305
MBT49UH	16.0	1,245.0	380.0	4,100	SS316	25	111-01306

All dimensions in mm. Subject to technical changes. The MBT-Series (up to 7.9 mm) can be used in combination with the stainless steel P-Mount. The mount is simple to install with a screw or bolt and ensures a durable fixing solution. Minimum Order Quantity (MOQ) may differ from package content. Other packaging options may also be available.



Please note! Not all products listed on this page may have this approval.

MBT Cable Ties Superior protection with high-grade stainless steel and specialist coating



MBT_SFC.

MBT_HFC.

Cable Ties with Ball-Lock and Coating

- MBT-FC-Series

The MBT range of stainless steel cable ties can be used in the most arduous of conditions or where the additional security, strength and fire resistance of a metal fixing is required. Used in all industries from mass transit, ship building, oil rigs, mining and chemical industry, theatres and exhibition halls. In the event of a fire, cables will remain securely held in place and will not fall to block emergency exits.

MATERIAL	Stainless Steel (SS316), Polyester (SP)
Operating Temperature	-80 °C to +538 °C
Operating Temperature Coating	-50 °C to +150 °C
Flammability	non-burning (except coating)



Features and Benefits

- Fully coated MBT, made from type 316 stainless steel with polyester coating
- Patented non-releasable locking feature
- Coated cable tie with smooth edges
- Comfortable handling and installation
- Eliminates contact corrosion between dissimilar materials during application

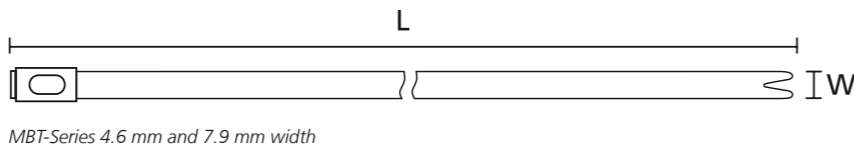

TYPE	Width (W)	Length (L)	Bundle Ø max.	N	Material	Pack Cont.	Article-No.
MBT5SFC	4.6	127.0	25.0	540	SS316, SP	100	111-00288
MBT8SFC	4.6	201.0	50.0	540	SS316, SP	100	111-00289
MBT14SFC	4.6	362.0	102.0	540	SS316, SP	100	111-00290
MBT20SFC	4.6	521.0	152.0	540	SS316, SP	100	111-00291
MBT27SFC	4.6	681.0	203.0	540	SS316, SP	100	111-00292
MBT33SFC	4.6	838.0	254.0	540	SS316, SP	100	111-00293
MBT8HFC	7.9	201.0	50.0	1,020	SS316, SP	50	111-00294
MBT14HFC	7.9	362.0	102.0	1,020	SS316, SP	50	111-00295
MBT20HFC	7.9	521.0	152.0	1,020	SS316, SP	50	111-00296
MBT27HFC	7.9	681.0	203.0	1,020	SS316, SP	50	111-00297
MBT33HFC	7.9	838.0	254.0	1,020	SS316, SP	50	111-00298

All dimensions in mm. Subject to technical changes. Minimum Order Quantity (MOQ) may differ from package content. Other packaging options may also be available.

MBT Cable Ties Superior protection with high-grade stainless steel and specialist coating



MBT_XHFC.

MBT_UHFC.

Cable Ties with Ball-Lock and Coating

- MBT-FC-Series

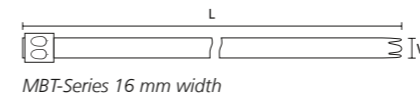
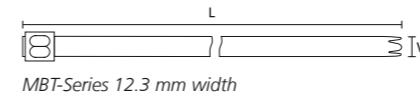

MATERIAL	Stainless Steel (SS316), Polyester (SP)
Operating Temperature	-80 °C to +538 °C
Operating Temperature Coating	-50 °C to +150 °C
Flammability	non-burning (except coating)



TYPE	Width (W)	Length (L)	Bundle Ø max.	N	Material	Pack Cont.	Article-No.
MBT14XHFC	12.3	362.0	102.0	1,620	SS316, SP	50	111-00299
MBT17XHFC	12.3	434.0	125.0	1,620	SS316, SP	50	111-01500
MBT20XHFC	12.3	521.0	152.0	1,620	SS316, SP	50	111-00300
MBT23XHFC	12.3	575.0	168.0	1,620	SS316, SP	50	111-01501
MBT27XHFC	12.3	681.0	203.0	1,620	SS316, SP	50	111-00301
MBT30XHFC	12.3	754.0	225.0	1,620	SS316, SP	50	111-01502
MBT33XHFC	12.3	838.0	254.0	1,620	SS316, SP	50	111-00302
MBT43XHFC	12.3	1,092.0	330.0	1,620	SS316, SP	25	111-01503
MBT49XHFC	12.3	1,245.0	380.0	1,620	SS316, SP	25	111-01504
MBT14UHFC	16.0	362.0	102.0	2,500	SS316, SP	50	111-01512
MBT17UHFC	16.0	434.0	125.0	2,500	SS316, SP	50	111-01513
MBT20UHFC	16.0	521.0	152.0	2,500	SS316, SP	50	111-01514
MBT23UHFC	16.0	575.0	168.0	2,500	SS316, SP	50	111-01515
MBT27UHFC	16.0	681.0	203.0	2,500	SS316, SP	50	111-01516
MBT30UHFC	16.0	754.0	225.0	2,500	SS316, SP	50	111-01517
MBT33UHFC	16.0	838.0	254.0	2,500	SS316, SP	50	111-01518
MBT43UHFC	16.0	1,092.0	330.0	2,500	SS316, SP	25	111-01519
MBT49UHFC	16.0	1,245.0	380.0	2,500	SS316, SP	25	111-01520

All dimensions in mm. Subject to technical changes. Minimum Order Quantity (MOQ) may differ from package content. Other packaging options may also be available.

MBT Double Wrap Cable Ties With double ball lock technology for extreme performance



MBT_XHD Double Wrap.

MBT_UHD Double Wrap.

Double Wrap Cable Ties with Ball-Lock

- MBTXHD- / MBTUHD-Series

The double wrap ties of the MBT-series are used in applications where a fixing requires an extraordinary high tensile strength.

Features and Benefits

- Stainless steel MBT ties with double wrap operation
- Wraps around the bundle and passes through the head twice
- Very high tensile strength to carry enormous applied loads
- Head with two locking balls
- Resistant to arduous conditions and environments

MATERIAL	Stainless Steel (SS316)
Operating Temperature	-80 °C to +538 °C
Flammability	non-burning

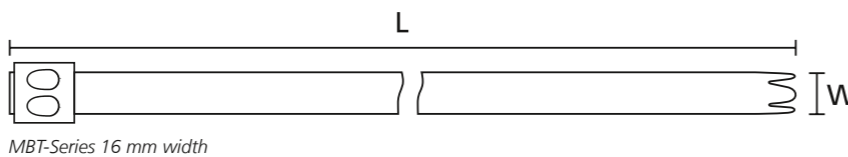
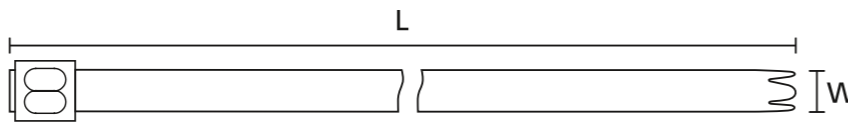

TYPE	Width (W)	Length (L)	Bundle Ø max.	N	Material	Pack Cont.	Article-No.
MBT27XHD	12.3	681.0	100.0	5,000	SS316	50	111-01307
MBT33XHD	12.3	838.0	120.0	5,000	SS316	50	111-01308
MBT43XHD	12.3	1,092.0	160.0	5,000	SS316	25	111-01309
MBT49XHD	12.3	1,245.0	180.0	5,000	SS316	25	111-01310
MBT60XHD	12.3	1,524.0	230.0	5,000	SS316	25	111-01311
MBT27UHD	16.0	681.0	100.0	7,000	SS316	50	111-01312
MBT33UHD	16.0	838.0	120.0	7,000	SS316	50	111-01313
MBT43UHD	16.0	1,092.0	160.0	7,000	SS316	25	111-01314
MBT49UHD	16.0	1,245.0	180.0	7,000	SS316	25	111-01315
MBT60UHD	16.0	1,524.0	230.0	7,000	SS316	25	111-01316

All dimensions in mm. Subject to technical changes.
Minimum Order Quantity (MOQ) may differ from package content. Other packaging options may also be available.

MBT Coated Double Wrap Cable Ties Combining high-tensile strength with specialist coating



MBT_XHDFC Double Wrap Coated.

MBT_UHDFC Double Wrap Coated.

Double Wrap Cable Ties with Ball-Lock and Coating

- MBTXHDFC- / MBTUHDFC-Series

The MBT range of stainless steel cable ties can be used in the most arduous of conditions or where the additional security, strength and fire resistance of a metal fixing is required. Used in all industries from mass transit, ship building, oil rigs, mining and chemical industry, theatres and exhibition halls. In the event of a fire, cables will remain securely held in place and will not fall to block emergency exits.

MATERIAL	Stainless Steel (SS316), Polyester (SP)
Operating Temperature	-80 °C to +538 °C
Operating Temperature Coating	-50 °C to +150 °C
Flammability	non-burning (except coating)



Features and Benefits

- MBT cable ties, made from stainless steel SS316 with a polyester coating
- Patented non-releasable locking feature
- Double wrap operation
- Corrosion resistant
- Weather resistant
- Outstanding chemical resistance
- Antimagnetic
- High temperature resistant
- Non-burning

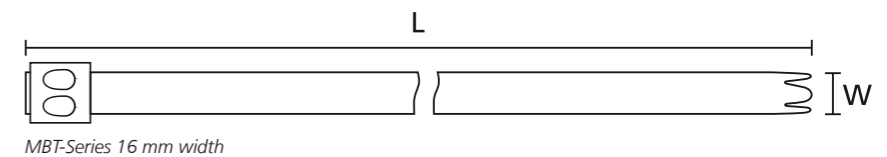
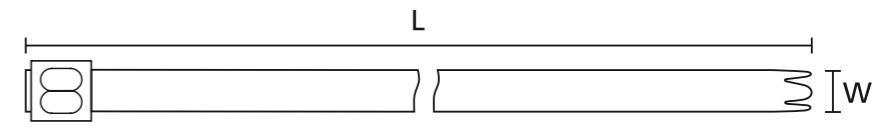

TYPE	Width (W)	Length (L)	Bundle Ø max.	N	Material	Pack Cont.	Article-No.
MBT27XHDFC	12.3	681.0	100.0	2,500	SS316, SP	50	111-01505
MBT33XHDFC	12.3	838.0	120.0	2,500	SS316, SP	50	111-01506
MBT43XHDFC	12.3	1,092.0	160.0	2,500	SS316, SP	25	111-01507
MBT49XHDFC	12.3	1,245.0	180.0	2,500	SS316, SP	25	111-01508
MBT60XHDFC	12.3	1,524.0	230.0	2,500	SS316, SP	25	111-01509
MBT27UHDFC	16.0	681.0	100.0	5,000	SS316, SP	50	111-01521
MBT33UHDFC	16.0	838.0	120.0	5,000	SS316, SP	50	111-01522
MBT43UHDFC	16.0	1,092.0	160.0	5,000	SS316, SP	25	111-01523
MBT49UHDFC	16.0	1,245.0	180.0	5,000	SS316, SP	25	111-01524
MBT60UHDFC	16.0	1,524.0	230.0	5,000	SS316, SP	25	111-01525

All dimensions in mm. Subject to technical changes.
Minimum Order Quantity (MOQ) may differ from package content. Other packaging options may also be available.

MLT Cable Ties

Your first choice for fold locking cable ties



MLT (uncoated).

MLT_C (coated).

Cable Ties with Fold Locking

• MLT-Series

• MLT-C-Series coated

Features and Benefits

- Releasable stainless steel buckle tie, MLT-series
- Heavy-duty type 316 stainless steel
- Can be re-opened and re-used
- Available also with polyester coating which prevents corrosion between dissimilar materials

MATERIAL	Stainless Steel (SS316)	Stainless Steel (SS316), Polyester (SP)
Operating Temperature	-80 °C to +538 °C	-80 °C to +538 °C
Operating Temp. Coating	-	-50 °C to +150 °C
Flammability	non-burning	non-burning (except coating)

HF ✓ LFH ✓ RoHS ✓

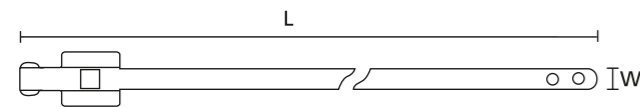

MLT tie

TYPE	Width (W)	Length (L)	Bundle Ø max.	N	Material	Pack Cont.	Article-No.
MLT-Series							
MLT8SS5	5.0	230.0	60.0	420	SS316	100	111-94080
MLT12SS5	5.0	330.0	90.0	420	SS316	100	111-94120
MLT16SS5	5.0	430.0	120.0	420	SS316	100	111-94161
MLT24SS5	5.0	630.0	180.0	420	SS316	100	111-91400
MLT8SS10	10.0	230.0	60.0	850	SS316	100	111-95080
MLT12SS10	10.0	330.0	90.0	850	SS316	100	111-95120
MLT16SS10	10.0	430.0	120.0	850	SS316	100	111-91300
MLT24SS10	10.0	630.0	180.0	850	SS316	100	111-95241
MLT-C-Series coated							
MLT8SSC5	5.3	230.0	60.0	420	SS316, SP	100	111-91000
MLT12SSC5	5.3	330.0	90.0	420	SS316, SP	100	111-91121
MLT16SSC5	5.3	430.0	120.0	420	SS316, SP	100	111-91161
MLT24SSC5	5.3	630.0	180.0	420	SS316, SP	100	111-91180
MLT8SSC10	10.3	230.0	60.0	850	SS316, SP	100	111-91001
MLT12SSC10	10.3	330.0	90.0	850	SS316, SP	100	111-91123
MLT16SSC10	10.3	430.0	120.0	850	SS316, SP	100	111-91163
MLT24SSC10	10.3	630.0	180.0	850	SS316, SP	100	111-91181

All dimensions in mm. Subject to technical changes. The MLT-Series (up to 10 mm) can be used in combination with the stainless steel P-Mount. The mount is simple to install with a screw or bolt and ensures a durable fixing solution. Minimum Order Quantity (MOQ) may differ from package content. Other packaging options may also be available.



Please note! Not all products listed on this page may have this approval.

AMT Metal Bandings

Ensures tight locking under vibration conditions



AMT.

Metal Banding for Heavy Duty Application

• AMT-Series

The AMT tie is designed for heavy duty applications. The folding mechanism ensures that the tie will not become loose under vibration. Therefore in all safety relevant areas where vibration is normal, such as in the rail, ship or construction industry, this product is ideal.

MATERIAL	Stainless Steel (SS316)
Operating Temperature	-80 °C to +538 °C
Flammability	non-burning

HF ✓ LFH ✓ RoHS ✓

Features and Benefits

- AMT ties for heavy-duty application
- Available in type 316 stainless steel
- Suitable for applications with high vibrations

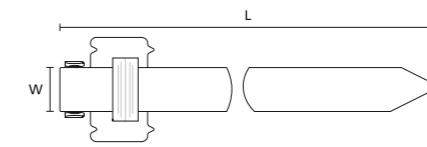

AMT tie



The high strength pre-assembled banding system – AMT tie.

TYPE	Width (W)	Length (L)	Thickness (T)	N	Material	Pack Cont.	Article-No.
AMT5L16SB	16.0	500.0	0.40	2,500	SS316	10	111-00327
AMT5H16SB	16.0	500.0	0.75	2,500	SS316	10	111-00338
AMT6L16SB	16.0	600.0	0.40	2,500	SS316	10	111-00328
AMT6H16SB	16.0	600.0	0.75	2,500	SS316	10	111-00339
AMT8L16SB	16.0	800.0	0.40	2,500	SS316	10	111-00329
AMT8H16SB	16.0	800.0	0.75	2,500	SS316	10	111-00340
AMT10L16SB	16.0	1,000.0	0.40	2,500	SS316	10	111-00330
AMT10H16SB	16.0	1,000.0	0.75	2,500	SS316	10	111-00341
AMT15L16SB	16.0	1,500.0	0.40	2,500	SS316	10	111-00331
AMT15H16SB	16.0	1,500.0	0.75	2,500	SS316	10	111-00342

All dimensions in mm. Subject to technical changes.

Minimum Order Quantity (MOQ) may differ from package content. Other packaging options may also be available.

MST Cable Ties Stainless steel metal tie with punch-locking mechanism



MST-Series.

Cable Ties with punch-locking mechanism

- MST-Series

Stainless steel cable ties are designed for fixing loads and cables securely in hazardous industrial environments such as railway carriages, in jet engines, inside power plants or on offshore drilling platforms, where exposure to extremes of weather, saltwater and temperature are common. The MST-Series tie with its new punch-locking mechanism is an excellent choice especially for environments which require high resistance to vibrations.

Features and Benefits

- MST-Series are made from stainless steel 304
- No loosening after bundling
- Corrosion and weather resistant
- Significantly improved vibration resistance
- Outstanding chemical resistance
- Space saving solution
- Safe cutting off (no sharp edges)
- Antimagnetic
- High temperature resistant
- Non-burning

MATERIAL	Stainless Steel (SS304)
Operating Temperature	-80 °C to +538 °C
Flammability	non-burning

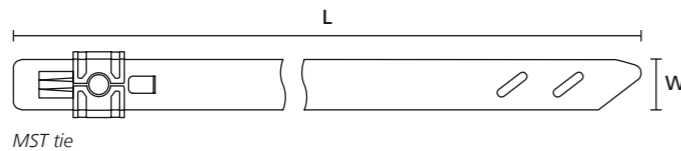

TYPE	Width (W)	Length (L)	Bundle Ø max.	N	Material	Pack Cont.	E-number	Article-No.
MST200S	5.9	207.0	50.0	900	SS304	100	00 000 00	111-01549
MST360S	5.9	360.0	100.0	900	SS304	100	00 000 00	111-01550
MST500S	5.9	500.0	145.0	900	SS304	100	00 000 00	111-01551
MST700S	5.9	700.0	205.0	900	SS304	100	00 000 00	111-01552

All dimensions in mm. Subject to technical changes. The MST-Series (up to 5.9 mm) can be used in combination with the stainless steel P-Mount. The mount is simple to install with a screw or bolt and ensures a durable fixing solution. Minimum Order Quantity (MOQ) may differ from package content. Other packaging options may also be available.

LFPC Protective Sleeves The ideal cable protection against abrasion and vibration



LFPC can be cut from the roll on every defined length.

Protective Channel for Stainless Steel Ties

- LFPC

When used in conjunction with the MBT, MST and AMT range of stainless steel cable ties this channel gives the cable protection against chafing, vibration and shock. Ideal for use in arduous conditions such as those found on board ships, oil rigs or in nuclear power stations.

MATERIAL	Polyolefin Compound unlinked (PO)
Colour	Black (BK)
Operating Temperature	-40 °C to +90 °C
Flammability	UL94 V0
Specification	DEF STAN 61-12 (Part 31)



Features and Benefits

- LFPC channel, manufactured from Polyolefin
- Works with MBT-, MST- and AMT-Series
- Smooth surface protects bundle against chafing caused by vibrations and shocks
- Can be cut from roll (50 m) to any length
- Halogenfree
- Flame retardant

The fire protection properties of the material relate to the test performed on defined test samples. This is a test under laboratory conditions and not directly transferable to the product made from this material.

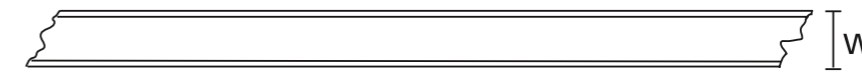

LFPC

TYPE	Width (W)	For Ties	Material	Pack Cont.	E-number	Article-No.
LFPC70	7.0	MBTS	PO	25 m	00 000 00	111-93000
LFPC83	8.3	MBTH	PO	25 m	00 000 00	111-00257
LFPC103	10.3	MBTH	PO	25 m	00 000 00	111-94000
LFPC129	12.9	MBTXH	PO	50 m	00 000 00	111-00253
LFPC132	13.2	MBTXH	PO	25 m	00 000 00	111-00254
LFPC150	15.0	MBTXH	PO	25 m	00 000 00	111-95000
LFPC163	16.3	AMT, MBTUH	PO	50 m	00 000 00	111-00255

All dimensions in mm. Subject to technical changes. Minimum Order Quantity (MOQ) may differ from package content. Other packaging options may also be available.



Please note! Not all products listed on this page may have this approval.

P-Mounts The one-hole fixing solution for heavy duty applications



P-Mounts.

Screw Fixing Mounts

- Stainless Steel 316 mounts

Suitable for the secure fixing of cables, tubing, conduits and pipes within the most arduous of environments. Providing a complete fastening and fixing solution when used in conjunction with stainless steel ties up to 10.0 mm width. They are ideal for use within shipbuilding, oil and gas (offshore), industrial machinery and vehicles, food and beverage, power, renewable energy and process industries.

Features and Benefits

- 2-way fixing for stainless steel ties
- High performance stainless steel 316 material
- 10 mm slot width
- Heavy duty design
- Resistant to a range of chemicals
- Weather and corrosion resistant
- Robust and durable solution
- Quick and easy to install
- Safe and secure solution for cables, tubing, conduits and pipes
- Ideal for a range of industries and applications

MATERIAL	Stainless Steel (SS316)
Operating Temperature	-80 °C to +538 °C
Flammability	non-burning



Note: It is recommended that stainless steel screws/bolts are used to install the P-Mounts to prevent potential corrosion.

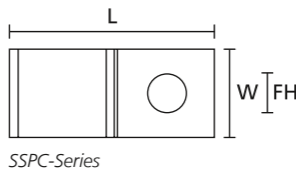

TYPE	Length (L)	Width (W)	Height (H)	Hole Ø (FH)	Material	Colour	Pack Cont.	Article-No.
SSPC4	23.0	10.2	4.5	4.2	SS316	Metal (ML)	100	151-00837
SSPC5	23.0	10.2	4.5	5.3	SS316	Metal (ML)	100	151-00838
SSPC6	23.0	10.2	4.5	6.3	SS316	Metal (ML)	100	151-00839

All dimensions in mm. Subject to technical changes. Minimum Order Quantity (MOQ) may differ from package content. Other packaging options may also be available.

Insulation SCT – Short circuit test

The perfect alternative to cable cleats



MBT tie with LFPC channel restraining cables in trefoil formation.

Short Circuit Test (SCT)

- MBT and AMT metal cable ties

HellermannTyton's single and double wrap metal ball and buckle ties fully withstand the maximum force of short circuits in trefoil formation, according to the results of laboratory tests conducted using the parameters outlined in the IEC 61914:2009 cable cleat standard.

The tests conducted by the NEFI High Power Laboratory in Norway – a member of the SATS Certification – demonstrated that our MBT and AMT stainless steel cable ties resist the huge forces unleashed by power cables in the event of a short circuit, even when they are installed in a 'worst case' trefoil formation (see drawing).

Construction of our SCT

The MBT and AMT metal ties were insulated from the cable jackets with LFPC polyolefin protective channels as an added layer of protection. Two different cable sizes, Ø 36 mm (300 mm²) and Ø 13 mm (50 mm²), each with 3 cables 8 m in length in trefoil formation, were tested with short circuit times between 0.2 and 0.5 seconds at various current levels.

What we achieved with our SCT

- We provide a fixing solution for low and medium voltage cables
- We ensure that our single and double wrap metal ball (MBT) and buckle ties (AMT) withstand a short circuit application
- We are able to offer a less expensive and process optimized alternative to cable cleats
- We have validated the formula for calculating maximum force on conductors during short circuits outlined in IEC61914:2009

Advantages of using HellermannTyton stainless steel cable ties over cable cleats:

- They can be used for inside and outside environment
- Very good heat and chemical resistance
- Due to the range of strap lengths and widths it is easy to choose a solution for every application
- Only one cable tie for many different cable diameters
- Cost saving solution
- Lower installation costs
- Low inventory value

$$F_t = 0.17 \times i_p^2 / S$$

Formula for calculating maximum force on conductors according to IEC 61914:2009.

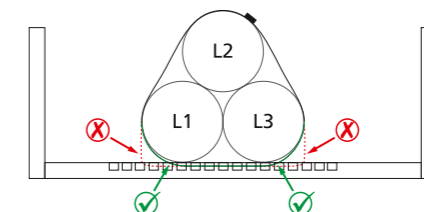

Best practice for installation. Ties should be bundled as close as possible for a smooth loop to avoid sharp edges.

Conclusion

- With the SCT we have proven that our MBT and AMT cable ties are suitable for low and medium voltage cable and withstand a certain level of short circuits.
- By using the IEC specified formula we are able to offer customers the right cable tie for their application.

The stainless steel cable ties from HellermannTyton are a perfect time saving solution for a low price and low installation cost.

HelaGuard Flexible Conduits

Optimum mechanical protection for the most rigorous applications

Metallic Conduits And Fittings



- High-grade, heavy-duty stainless and galvanised steel conduits
- High compression, impact and tensile strength
- Large variety of diameters
- Sturdy stainless steel and nickel-plated brass fittings

SSC Stainless Steel Conduits

Reliable mechanical protection in the most corrosive environments



HelaGuard SSC stainless steel conduit offers superior mechanical protection in corrosive environments.

Metallic conduits

• SSC Stainless steel conduit

Stainless steel, corrosion-resistant flexible conduit used for protection of sensor cables, instrumentation tubing, as well as hydraulic and pneumatic conduits, particularly in corrosive environments. Commonly used in hospitals and clinics.

MATERIAL	Stainless Steel (SS316)
Operating Temperature	-100 °C to +400 °C



Features and Benefits

- Highly resistant to rust and corrosion
- High compression, tensile and impact strength
- Very flexible

TYPE	Nominal Ø	Outside Ø (OD)	Inside Ø	Bending Radius	Weight (g/m)	Reel Length	Colour	Article-No.
SSC10	10	9.1	6.8	25	110	25 m	Metal (ML)	166-30200
SSC12	12	12.3	10.2	30	126	25 m	Metal (ML)	166-30201
SSC16	16	16.4	13.0	40	162	25 m	Metal (ML)	166-30202
SSC20	20	20.4	16.9	45	202	25 m	Metal (ML)	166-30203
SSC25	25	24.3	21.1	55	300	25 m	Metal (ML)	166-30204
SSC32	32	31.7	28.1	70	340	25 m	Metal (ML)	166-30205
SSC40	40	42.1	37.6	80	410	10 m	Metal (ML)	166-30206
SSC50	50	52.8	48.4	90	516	10 m	Metal (ML)	166-30207

All dimensions in mm. Subject to technical changes.
Other reel lengths available on request. Minimum Order Quantity (MOQ) may differ from package content.

SC Galvanised Steel Conduits

Combining flexibility with high strength

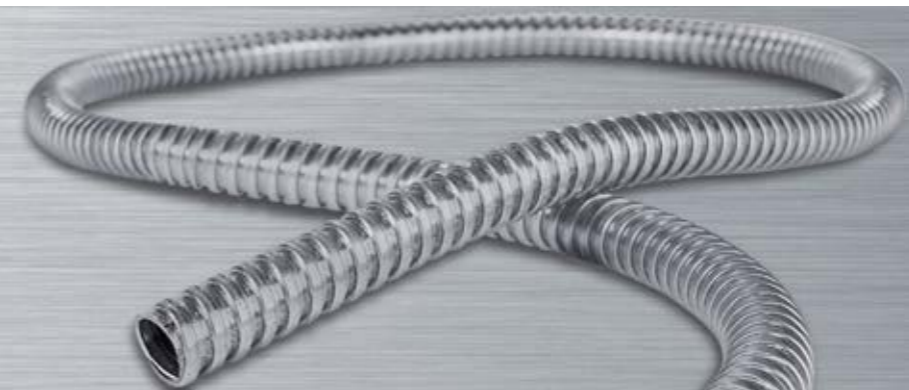

HelaGuard SC galvanised steel conduit.

Metallic conduits

• SC Galvanised steel conduit

General purpose flexible steel conduit offers high mechanical protection and is typically used in machines, plants, underfloor wiring, data cabling and protection of hydraulic or pneumatic conduits.

MATERIAL	Galvanised Steel (GS)
Operating Temperature	-100 °C to +300 °C



Features and Benefits

- High compression, tensile and impact strength
- Very flexible

TYPE	Nominal Ø	Outside Ø (OD)	Inside Ø	Bending Radius	Weight (g/m)	Reel Length	Colour	Article-No.
SC10	10	9.1	6.8	25	110	50 m	Metal (ML)	166-30100
SC12	12	13.2	10	30	113	50 m	Metal (ML)	166-30101
SC16	16	16.4	12.9	40	152	25 m	Metal (ML)	166-30102
SC20	20	20.6	16.9	45	295	25 m	Metal (ML)	166-30103
SC25	25	24.6	21.1	55	321	25 m	Metal (ML)	166-30104
SC32	32	32.0	28.1	70	450	25 m	Metal (ML)	166-30105
SC40	40	42.5	37.6	80	519	25 m	Metal (ML)	166-30106
SC50	50	53.2	48.4	90	802	25 m	Metal (ML)	166-30107
SC63	63	62.5	57.5	115	836	10 m	Metal (ML)	166-30108
SC75	75	77.0	70.0	150	1,137	10 m	Metal (ML)	166-30109

All dimensions in mm. Subject to technical changes.
Other reel lengths available on request. Minimum Order Quantity (MOQ) may differ from package content.

SSC Stainless Steel Metallic Fittings

For a complete, corrosion-resistant installation



HelaGuard SSC-FM with fixed external thread.

HelaGuard SSC-SM with swivel external thread.

Fittings for metallic conduits

• SSC-FM Fixed external thread

Fixed external thread, stainless steel (SS316).

Features and Benefits

- Two-part fitting of shell and body with external thread
- Highly resistant to rust and corrosion
- Provides tight, reliable hold of conduit
- Can be secured with locknut

• SSC-SM Swivel external thread

Swivel external thread, stainless steel (SS316).

Features and Benefits

- Two-part fitting of shell and body with external thread
- Highly resistant to rust and corrosion
- External thread swives about main body
- Provides tight, reliable hold of conduit
- Can be secured with locknut

MATERIAL	Stainless Steel (SS316)
Operating Temperature	-100 °C to +400 °C



TYPE	Nominal Ø	Thread Size (metric)	Min. Bore Size (B)	Length (L)	A/F Body	Thread Length	Pack Cont.	Colour	Article-No.
SSC-FM Fixed external thread									
SSC10-FM-M12	10	M12	5.6	21.0	14	8.0	1 pcs.	Metal (ML)	166-30321
SSC12-FM-M16	12	M16	8.5	23.0	19	8.0	1 pcs.	Metal (ML)	166-30322
SSC16-FM-M16	16	M16	11.5	25.0	19	10.0	1 pcs.	Metal (ML)	166-30323
SSC20-FM-M20	20	M20	15.3	26.3	24	10.0	1 pcs.	Metal (ML)	166-30324
SSC25-FM-M25	25	M25	19.1	32.5	29	10.0	1 pcs.	Metal (ML)	166-30325
SSC32-FM-M32	32	M32	26.2	36.8	38	13.0	1 pcs.	Metal (ML)	166-30326
SSC40-FM-M40	40	M40	34.6	39.0	48	14.0	1 pcs.	Metal (ML)	166-30327
SSC50-FM-M50	50	M50	44.7	44.5	58	15.0	1 pcs.	Metal (ML)	166-30328
SSC-SM Swivel external thread									
SSC10-SM-M12	10	M12	5.6	30.2	14	8.0	1 pcs.	Metal (ML)	166-30419
SSC12-SM-M16	12	M16	8.5	32.2	19	8.0	1 pcs.	Metal (ML)	166-30420
SSC16-SM-M16	16	M16	11.5	34.2	19	10.0	1 pcs.	Metal (ML)	166-30421
SSC20-SM-M20	20	M20	15.3	35.5	24	10.0	1 pcs.	Metal (ML)	166-30422
SSC25-SM-M25	25	M25	19.1	43.7	29	10.0	1 pcs.	Metal (ML)	166-30423
SSC32-SM-M32	32	M32	26.2	48.0	38	13.0	1 pcs.	Metal (ML)	166-30424

All dimensions in mm. Subject to technical changes.
Minimum Order Quantity (MOQ) may differ from package content.

SC Metallic Fittings

For a secure and reliable hold



HelaGuard SC-FM with fixed external thread.

HelaGuard SC-SM with swivel external thread.

Fittings for metallic conduits

• SC-FM Fixed external thread

Fixed external thread, nickel plated brass.

Features and Benefits

- Two-part fitting of shell and body with external thread
- Provides tight, reliable hold of conduit
- Can be secured with locknut

• SC-SM Swivel external thread

Swivel external thread, nickel plated brass.

Features and Benefits

- Two-part fitting of shell and body with external thread
- External thread swives about main body
- Provides tight, reliable hold of conduit
- Can be secured with locknut

MATERIAL	Nickel Plated Brass (NPB)
Operating Temperature	-100 °C to +300 °C



• SC-FM Fixed external thread

• SC-SM Swivel external thread

TYPE	Article-No.	TYPE	Article-No.	Nominal Ø	Thread Size (metric)	Thread Size (PG)	Pack Cont.
SC10-FM-PG7	166-30311	SC10-SM-PG7	166-30410	10	-	PG7	10 pcs.
SC10-FM-M12	166-30300	SC10-SM-M12	166-30400	10	M12	-	10 pcs.
SC12-FM-PG9	166-30313	SC12-SM-PG9	166-30411	12	-	PG9	10 pcs.
SC12-FM-M16	166-30301	SC12-SM-M16	166-30401	12	M16	-	10 pcs.
SC16-FM-PG11	166-30314	SC16-SM-PG11	166-30412	16	-	PG11	10 pcs.
SC16-FM-M16	166-30302	SC16-SM-M16	166-30402	16	M16	-	10 pcs.
SC16-FM-M20	166-30303	SC16-SM-M20	166-30403	16	M20	-	10 pcs.
-	-	SC20-SM-PG13	166-30413	20	-	PG13.5	10 pcs.
SC20-FM-PG16	166-30315	SC20-SM-PG16	166-30414	20	-	PG16	10 pcs.
SC20-FM-M20	166-30304	SC20-SM-M20	166-30404	20	M20	-	10 pcs.
SC25-FM-PG21	166-30316	SC25-SM-PG21	166-30415	25	-	PG21	10 pcs.
SC25-FM-M25	166-30305	SC25-SM-M25	166-30405	25	M25	-	10 pcs.
SC32-FM-PG29	166-30317	SC32-SM-PG29	166-30416	32	-	PG29	2 pcs.
SC32-FM-M32	166-30306	SC32-SM-M32	166-30406	32	M32	-	2 pcs.
SC40-FM-PG36	166-30318	SC40-SM-PG36	166-30417	40	-	PG36	2 pcs.
SC40-FM-M40	166-30307	SC40-SM-M40	166-30407	40	M40	-	2 pcs.
SC50-FM-PG42	166-30319	SC50-SM-PG42	166-30418	50	-	PG42	1 pcs.
SC50-FM-M50	166-30308	SC50-SM-M50	166-30408	50	M50	-	1 pcs.
SC63-FM-PG48	166-30320	-	-	63	-	PG48	1 pcs.
SC63-FM-M63	166-30309	SC63-SM-M63	166-30409	63	M63	-	1 pcs.
SC75-FM-M75	166-30310	-	-	75	M75	-	1 pcs.

All dimensions in mm. Subject to technical changes.
Minimum Order Quantity (MOQ) may differ from package content.

Manual & Pneumatic Processing Tools

The best way to fasten your metal cable ties

Perfect Solution For Fast And Easy Working



- Designed for perfect handling
- A tool for every cable tie
- Manual and pneumatic processing
- For heavy-duty purposes



HDT-Tool Ergonomically designed tool for use with 16 mm MBT/AMT stainless steel ties



HDT16-Tool.

Manual Tensioning Tool for Metal Ties MBT- and AMT-Series

- HDT16 up to 16.0 mm strap width

The HDT16 application tool is designed for installing heavy duty stainless steel cable ties within a range of industries such as shipbuilding, oil rigs, mining and mass transit. The tool can easily be adjusted making it suitable for applying both MBT and AMT cable ties with a strap width of up to 16 mm.

Features and Benefits

- Two way nose piece for use with both MBT-Series and AMT-Series stainless steel cable ties
- Easy adjustment of the handles to ensure the most ergonomic position for the operator
- Integrated cutting mechanism delivering a flush cut and professional finish every time
- The ideal tool for achieving a perfect installation of MBT and AMT cable ties



Special two way nose piece for MBT ties.



Special two way nose piece for AMT ties.

TYPE	Strap Width max. (G)	Article-No.
HDT16	16.0	110-40000

All dimensions in mm. Subject to technical changes.

Processing Tools The best choice for applying stainless steel cable ties



MK9PSST.

Pneumatic Tensioning Tool with Plastic Housing

- MK9PSST up to 16.0 mm strap width

Features and Benefits

- Unique levels of repeatability and accuracy
- High application speed and low maintenance
- Improved compressed air supply for faster tensioning piston movement
- Shorter processing time and greater volume of connecting tie application
- Ergonomic design
- Automatic ejection of cut-off cable tie end
- Ideally designed to apply stainless steel MBT-Series up to 16.0 mm width
- On air pressure between 3 and 6 bar

- MK9PSST up to 16.0 mm strap width

TYPE	Strap Width max. (G)	Strap Thickness max.	Weight	Article-No.
MK9PSST	16.0	0.7	0.91 kg	110-95350

All dimensions in mm. Subject to technical changes.

- MK9SST up to 16.0 mm strap width

TYPE	Strap Width max. (G)	Strap Thickness max.	Weight	Article-No.
MK9SST	16.0	0.3	0.6 kg	110-95000

All dimensions in mm. Subject to technical changes.

- KST-STG200 up to 12.3 mm strap width

TYPE	Strap Width max. (G)	Strap Thickness max.	Weight	Article-No.
KST-STG200	12.3	0.3	0.561 kg	110-09950

All dimensions in mm. Subject to technical changes.



MK9SST.

Manual Tensioning Tool for Metal Ties MBT-Series

- MK9SST up to 16.0 mm strap width

Features and Benefits

- Glass-fibre-reinforced housing
- Ergonomic design
- Consistent tensioning and automatically cutting of metal ties MBT/MAT-series
- Infinitely adjustable tension force combined with two-step quick adjustment



KST-STG200.

Manual Tensioning Tool for Metal Ties MBT-Series

- KST-STG200 up to 12.3 mm strap width

Features and Benefits

- Tough metal tool
- Operator controlled tensioning
- Cut off by pulling the hand lever

Processing Tools Ergonomic, lightweight tools for heavy duty applications



MST6 Tool.

Manual Tensioning Tool for Metal Ties MST-Series

- MST6 up to 5.9 mm strap width

The MST6 tool has been specially developed for reliably applying HellermannTyton metal cable ties of the MST-Series. Due to the punch-lock mechanism the tie is mechanically crimped and leads to metal deformation of the tie ends. This punch-lock mechanism ensures a reliable bundling with perfect resistance to vibration. The tension force is freely adjustable by the operator.

Features and Benefits

- Tough metal tool
- Ergonomic design
- Consistent tensioning and automatically cutting of metal ties
- Designed for use with MST-S Series ties (5.9 mm)
- For tensioning, fixing and cutting MST-S metal ties

- MST6 up to 5.9 mm strap width

TYPE	Strap Width max. (G)	Strap Thickness max.	Weight	Article-No.
MST6	5.9	0.3	0.525 kg	110-61000

All dimensions in mm. Subject to technical changes.

- MTT4 up to 12.0 mm strap width

TYPE	Strap Width max. (G)	Strap Thickness max.	Weight	Article-No.
MTT4	12.0	0.7	0.78 kg	110-04000

All dimensions in mm. Subject to technical changes.

- THT up to 7.9 mm strap width

TYPE	Strap Width max. (G)	Strap Thickness max.	Weight	Article-No.
THT Tool	7.9	1.0	0.145 kg	110-09970

All dimensions in mm. Subject to technical changes.

MTT4.

Manual Tensioning Tool for Metal Ties MLT-Series

- MTT4 up to 12.0 mm strap width

The MTT4 tensioning tool is a lightweight manual processing tool which is easy to use for application of the MLT (releasable) series. The extended nose piece ensures the fixing length of the MLT cable tie. While using the ratchet system, the operator can easily cut off the tie on the correct length with the long cutter lever.

Features and Benefits

- Tough metal tool
- Simple ratchet operation, easy to use
- Operator controlled tensioning and cutting facility

THT Tool.

Manual Tensioning Tool for Metal Ties

- THT up to 7.9 mm strap width

The THT Tool is ideal for customers purchasing HellermannTyton's MBT Kit that require additional tools, or for occasional users of stainless steel MBT cable ties. The THT Tool allows simple hand tensioning of MBT ties for quick and easy installations, coiling the tail for a safe, neat finish.

Features and Benefits

- Ergonomic T-Handle design with rubber grip
- Suitable for MBT cable ties (4.6 mm and 7.9 mm)
- Simple tensioning mechanism coils the strap tail quickly without cut off

HellermannTyton One company – more than 60,000 cable management solutions.

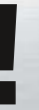

Cable management solutions designed to meet your individual needs

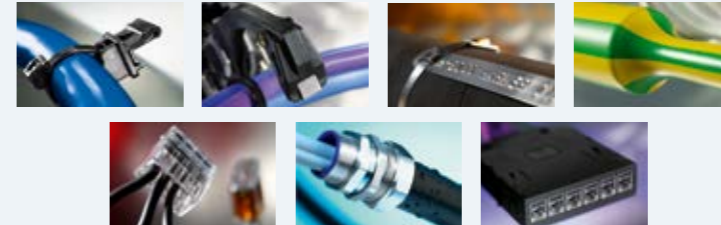

HellermannTyton is a global manufacturer offering more than **60,000 high-performance** fastening, connecting, routing, protecting and identifying **solutions** to diverse markets.

Located in 35 countries, HellermannTyton draws upon its global resources and market position to develop tailored solutions that offer exceptional design, performance, quality, and productivity improvements to the customer.



Catalogue available in 16 languages



More than 60,000 solutions at your fingertips: The HellermannTyton App

Available on the App Store



Let's go mobile ...

HellermannTyton

Expertise worldwide – you will find your local contact here:

Europe

 **HellermannTyton GmbH – Austria**
Rennbahnweg 65
1220 Vienna
Tel: +43 12 59 99 55-0
Fax: +43 12 59 99 11
E-Mail: office@HellermannTyton.at
www.HellermannTyton.at

 **HellermannTyton – Czech Republic**
E-Mail: officeCZ@HellermannTyton.at
www.HellermannTyton.cz

 **HellermannTyton – Denmark**
Baldersbuen 15D 1. TV
2640 Hedehusene
Tel: +45 702 371 20
Fax: +45 702 371 21
E-Mail: htdk@HellermannTyton.dk
www.HellermannTyton.dk

 **HellermannTyton – Finland**
Sähkötie 8
01510 Vantaa
Tel: +358 9 8700 450
Fax: +358 9 8700 4520
E-Mail: myynti@HellermannTyton.fi
www.HellermannTyton.fi

 **HellermannTyton S.A.S. - France**
2 rue des Hêtres, C.S. 80543
78197 Trappes Cedex
Tel: +33 1 30 13 80 00
Fax: +33 1 30 13 80 60
E-Mail: info@HellermannTyton.fr
www.HellermannTyton.fr

 **HellermannTyton GmbH – Germany**
Großer Moonweg 45
25436 Tornesch
Tel: +49 4122 701-0
Fax: +49 4122 701-400
E-Mail: info@HellermannTyton.de
www.HellermannTyton.de

 **HellermannTyton KFT – Hungary**
Kisfaludy u. 13
1044 Budapest
Tel: +36 1 369 4151
Fax: +36 1 369 4151
E-Mail: officeHU@HellermannTyton.at
www.HellermannTyton.hu

 **HellermannTyton Ltd – Ireland**
Unit 77 Cherry Orchard
Industrial Estate
Ballyfermot, Dublin 10
Tel: +353 1 626 8267
Fax: +353 1 626 8022
E-Mail: sales@HellermannTyton.ie
www.HellermannTyton.co.uk

 **HellermannTyton S.r.l. – Italy**
Via Praimbole 9 Bis
35010 Limena (PD)
Tel: +39 049 767 870
Fax: +39 049 767 985
E-Mail: info@HellermannTyton.it
www.HellermannTyton.it

 **HellermannTyton B.V. – Belgium/Netherlands**
Vanadiumweg 11-C
3812 PX Amersfoort
Tel: +31 33 460 06 90
Fax: +31 33 460 06 99
E-Mail (NL): info@HellermannTyton.nl
E-Mail (BE): info@HellermannTyton.be
www.HellermannTyton.nl
www.HellermannTyton.be

 **HellermannTyton AS – Norway**
PO Box 240 Alnabru
0614 Oslo
Tel: +47 23 17 47 00
Fax: +47 22 97 09 70
E-Mail: firmapost@HellermannTyton.no
www.HellermannTyton.no

 **HellermannTyton Sp. z o.o. – Poland**
ul. Berdychów 57A
62-410 Zagorów
E-Mail: info@HellermannTyton.pl
www.HellermannTyton.pl

 **HellermannTyton – Romania**
E-Mail: officeRO@HellermannTyton.at
www.HellermannTyton.at

 **OOO HellermannTyton – Russia**
40/4, Pulkovskoe road
BC Technopolis Pulkovo, office A 8081
196158, St. Petersburg
Tel: +7 812 386 00 09
Fax: +7 812 386 00 08
E-Mail: info@HellermannTyton.ru
www.HellermannTyton.ru

 **HellermannTyton – Slovenia**
Branch Office Ljubljana
Podružnica Ljubljana, Leskoškova 6
1000 Ljubljana
Tel: +386 1 433 70 56
Fax: +386 1 433 63 21
E-Mail: officeSI@HellermannTyton.at
www.HellermannTyton.si

 **HellermannTyton España s.l. – Spain/Portugal**
Avda. de la Industria nº 37, 2º 2ª
28.108 Alcobendas, Madrid
Tel: +34 91 661 2835
Fax: +34 91 661 2368
E-Mail:
HellermannTyton@HellermannTyton.es
www.HellermannTyton.es

 **HellermannTyton AB – Sweden**
Datavägen 5, PO Box 569
17526 Järfälla
Tel: +46 8 580 890 00
Fax: +46 8 580 890 01
E-Mail: support@HellermannTyton.se
www.HellermannTyton.se

 **HellermannTyton Ltd – UK**
William Prance Road
Plymouth International Medical
and Technology Park
Plymouth, Devon PL6 5WR
Tel: +44 1752 701 261
Fax: +44 1752 790 058
E-Mail: info@HellermannTyton.co.uk
www.HellermannTyton.co.uk

 **HellermannTyton Ltd – UK**
Sharston Green Business Park
1 Robeson Way
Altrincham Road, Wythenshawe
Manchester M22 4TY
Tel: +44 161 947 2200
Fax: +44 161 947 2220
E-Mail: sales@HellermannTyton.co.uk
www.HellermannTyton.co.uk

 **HellermannTyton Ltd – UK**
Main Contact for Customer Service
Wharf Approach
Aldridge, Walsall, West Midlands
WS9 8BX
Tel: +44 1922 458 151
Fax: +44 1922 743 053
E-Mail: info@HellermannTyton.co.uk
www.HellermannTyton.co.uk

 **HellermannTyton Data Ltd – UK**
Cornwell Business Park
43-45 Salthouse Road, Brackmills
Northampton NN4 7EX
Tel: +44 1604 707 420
Fax: +44 1604 705 454
E-Mail: sales@htdata.co.uk
www.htdata.co.uk

North America

 **HellermannTyton – Canada**
Tel: +1 905 726 1221
Fax: +1 905 726 8538
E-Mail: sales@HellermannTyton.ca
www.HellermannTyton.ca

 **HellermannTyton – Mexico**
Tel: +52 333 133 9880
Fax: +52 333 133 9861
E-Mail: info@HellermannTyton.com.mx
www.HellermannTyton.com

 **HellermannTyton – USA**
Tel: +1 414 355 1130
Fax: +1 414 355 7341
E-Mail: corp@htamericas.com
www.HellermannTyton.com

South America

 **HellermannTyton – Argentina**
Tel: +54 11 4754 5400
Fax: +54 11 4752 0374
E-Mail: ventas@HellermannTyton.com.ar
www.HellermannTyton.com.ar

 **HellermannTyton – Brazil**
Tel: +55 11 4815 9000
Fax: +55 11 4815 9030
E-Mail: vendas@HellermannTyton.com.br
www.HellermannTyton.com.br

Asia-Pacific

 **HellermannTyton – Australia**
Tel: +61 2 9525 2133
Fax: +61 2 9526 2495
E-Mail: cservice@HellermannTyton.com.au
www.HellermannTyton.com.au

 **HellermannTyton – China**
Tel: +86 510 8528 2536
Fax: +86 510 8528 2731
E-Mail:
cservice@HellermannTyton.com.cn
www.HellermannTyton.com.cn

 **HellermannTyton – Hong Kong**
Tel: +852 2832 9090
Fax: +852 2832 9381
E-Mail:
cservice@HellermannTyton.com.hk
www.HellermannTyton.com.sg

 **HellermannTyton – India**
Tel: +91 120 413 3384
Bangalore: +91 776 001 0104
Chennai: +91 996 264 3939
Faridabad: +91 971 851 7797
Ghaziabad: +91 93 1354 1671
Pune: +91 727 601 2200
E-Mail: cservice@HellermannTyton.co.in
www.HellermannTyton.co.in

 **HellermannTyton – Japan**
Tel: +81 3 5790 3111
Fax: +81 3 5790 3112
E-Mail: cservice@HellermannTyton.co.jp
www.HellermannTyton.co.jp

 **HellermannTyton – Republic of Korea**
Tel: +82 31 388 8012
Fax: +82 31 388 8013
E-Mail: cservice@HellermannTyton.co.kr
www.HellermannTyton.co.kr

 **HellermannTyton – Philippines**
Tel: +63 2 752 6551
Fax: +63 2 752 6553
E-Mail: cservice@HellermannTyton.com.ph
www.HellermannTyton.com.ph

 **HellermannTyton – Singapore**
Tel: +65 6 852 8585
Fax: +65 6 756 6798
E-Mail: cservice@HellermannTyton.sg
www.HellermannTyton.com.sg

 **HellermannTyton – Thailand**
Tel: +662 237 6702 / 266 0624
Fax: +662 266 8664
E-Mail: cservice@HellermannTyton.co.th
www.HellermannTyton.com.sg

Africa

 **HellermannTyton – South Africa**
Tel: +27 11 879 6680
Fax: +27 11 879 6601
E-Mail: sales.jhb@HellermannTyton.co.za
www.HellermannTyton.co.za

www.HellermannTyton.com

HellermannTyton